



901-092
18' x 20' Shade Structure

Installation Instruction

SportsPlay Equipment

www.sportsplayinc.com

For this structure the following have been supplied:

Item	Part Number	Description	QTY
1	905-092	Shade Canopy 18' x 20'	1
2	905-097	Corner Connector	4
3	905-098	Y Connector	2
4	904-095	Perimeter cable 12 x 20	1
5	913-091	3.5" O.D. x 10' Columns	4
6	903-702	2.375" O.D. x 149.5" Hoop Pipe	4
7	903-703	2.375" O.D. x 32.375" Hip Pipe	1
8	905-526	Self Drilling Screw	10
9	126-815	1/2" x 5" Hex Bolt	4
10	316-801	1/2" Washer	8
11	226-802	1/2" Nylon Lock Nut	4
12	905-262	Torx Bit	2
13	N/A	D-Shackle Cable Connector	4
14			

Other Materials

The concrete required for the project needs to be sourced locally by the contractor. Use normal Post pre-mix bagged concrete available from building material outlets

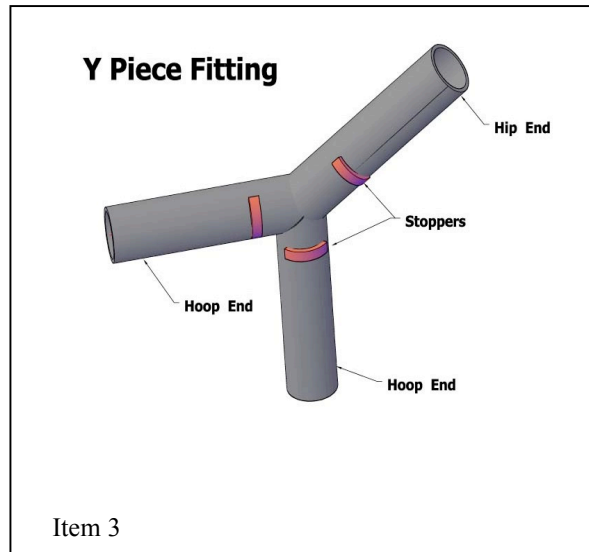
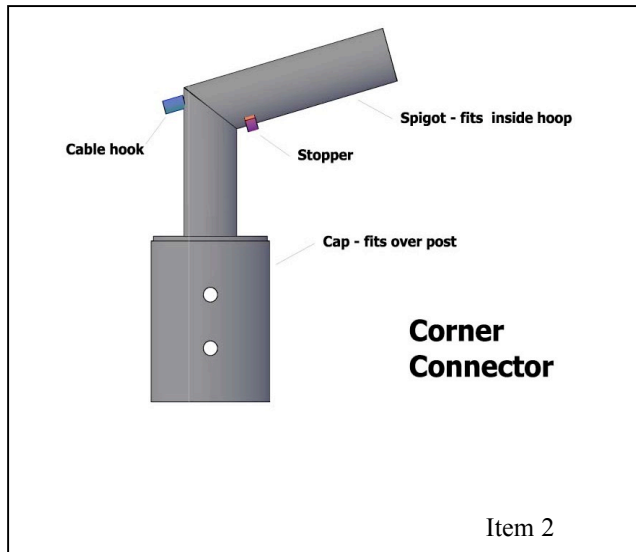

General Information

Note that the installation of a shade structure takes place in 2 separate stages and at will require at least two visits to the jobsite.

- **Stage 1** entails the marking of the foundation holes, the digging of the foundations, the installation of the posts & related concrete work to secure the posts in place. Once the posts are installed & the concrete work is finished, no further work can be done on-site at that moment. Adequate time must be allowed for the concrete to cure & set properly, prior to starting with stage 2 of the installation.

Concrete curing time is subject to a number of variables. Make sure these are properly observed and that the concrete reaches almost full curing strength, typically 24 – 48 hours, before starting with stage 2. Refer to the concrete manufacturer's instructions to verify the required curing time.

The foundation size indicated in this manual is a suggested minimum size only. Please refer to your local regulations and wind code requirements in order to determine the correct foundation size. Seek professional help if required.

- **Stage 2** entails the leveling of the tops of the posts, the installation of the fittings and the steel tubing for the shadenet support structure. Once this is done the shadenet is fitted over the support structure and secured with the cable.

Keep the shade out of the sun until you are ready to actually install it. The shade will shrink if left exposed for a period of time.

Also, be very careful not to step on the shade or run it over sharp surfaces that could cut the material.

Experience in constructing steel structures is necessary.

Installation Instructions

Step 1: Marking out & digging the foundations.

1. The first step is to mark out the position of the 4 foundation holes, where the posts will be planted. It is important to ensure that the 4 posts are at the correct distances from each other, including the diagonal distances. The measurements given below are taken from the center of one post to the center of another post.
2. Ideally the post must be positioned in the centre of the foundation hole so try and dig your holes straight down and on your mark to ensure proper alignment. Start with the hole that is at the lowest grade using a transit to ensure all other holes are at the same grade as the first, this will ensure all posts are at the same height once they are installed. Ensure that the required depth of the foundation hole is reached & remove any debris from the foundation hole.
3. If the foundation holes have to be dug with spades, demarcate the required hole size around the marker. Ensure that the foundation hole is uniform in size and that the post will be located at the center of the hole after installation. Remove any debris from the foundation hole.

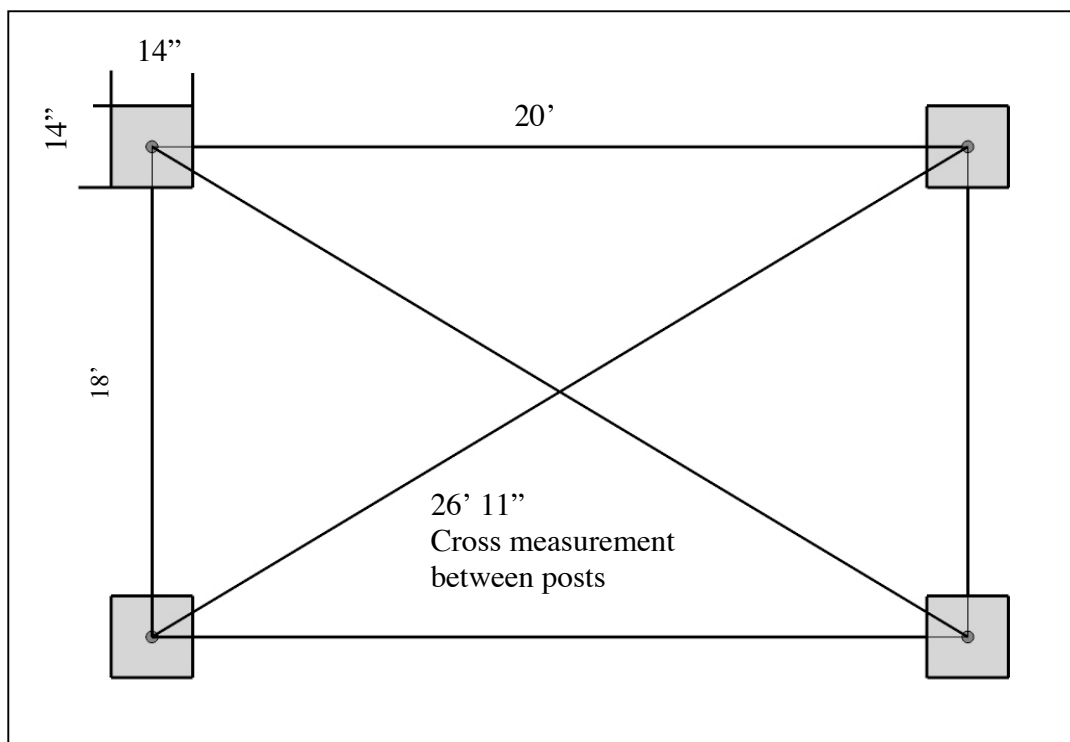

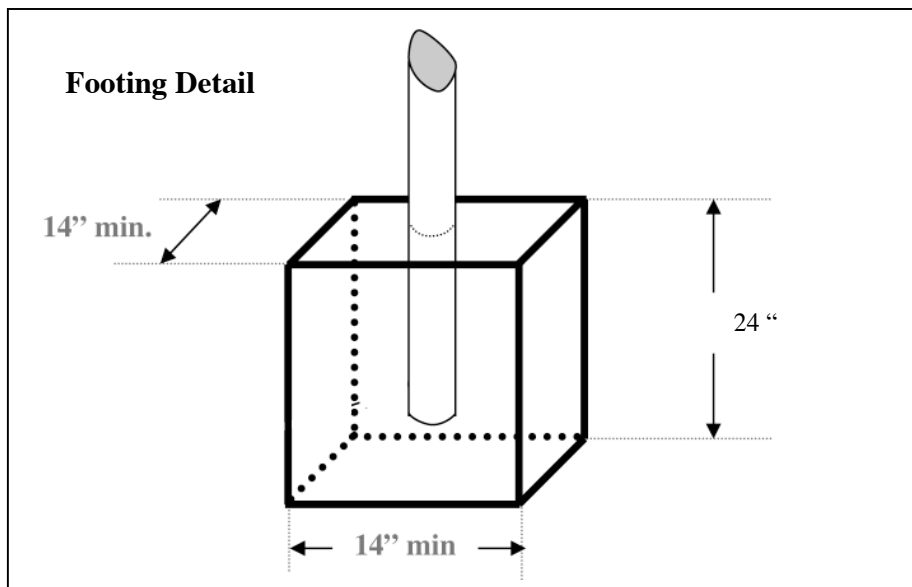

Step 2: Planting the Posts

You will now need the following equipment and pieces:

- (4) 3.5" O.D. x 10' Columns – Item 5
- Pre-mix Concrete
- Spades & agitator stick to maneuver the wet concrete
- Water to mix with the dry concrete
- Something to mix the concrete in (ex. Wheel barrel).
- A wheelbarrow to carry the concrete to the hole.
- Tape measures of adequate length to measure the diagonals. (min 25').
- 2 levels (preferably magnetic).

Note that a relatively “dry” mix of concrete is required. The wet concrete must be of adequate viscosity that it will keep the post in the upright and level position, without the post falling over sideways.

1. Insert a 3.5" O.D. column (item 5) into the center of one of the foundation holes ensuring the smashed end of the column is in the hole.
2. Using the two levels make sure the column is level in all directions. The column must be at a 90° plumb angle to the foundation on both axis.
3. While 1 member of the installation team holds & keeps the post in the level position, another member of the team can start filling up the foundation with wet concrete. Use the agitator stick to ensure the concrete fills up the entire foundation hole. Take care that the base of the post is not pushed out of position by the concrete or the agitator stick.
4. Assuming the foundation holes were dug at the correct distances, the post must remain in the center of the foundation hole.

5. **It is critical that the post must be constantly monitored & kept upright and level during the concrete filling process. Avoid any unnecessary movement of the post.** The easiest way to keep the posts level is to shore them up with temporary bracing or scaffolding.
6. You may now install the remaining posts. Please ensure that no movement occurs on the 1st post once it is left standing on its own – hence the requirement for a relatively dry concrete mix. Also ensure that the correct center post to center post measurements are adhered to and **include the diagonal measurements** to obtain the correct positions for all posts.

Step 1 of installation is now complete. Please clean up the site and remove all rubble. Also ensure the site is clearly marked closed and that no unauthorized access can take place prior to the concrete setting firm.

(Murphy's Law dictates that kids, if unhindered, will swing from posts with wet foundations.)

Step 2: Leveling the posts & installing the top structure

You are now planning to return back to the site, the concrete having had adequate time to cure properly.

You will now need the following equipment and Pieces:

- A steel pipe cutter that can accommodate a tube diameter of 3 ½" (a reciprocating saw with metal blade can also be used)
- A flexible clear see – through plastic tube, large inner bore size, outside diameter at least 3/4". This tube will be used as a water level in order to trim the top of the posts down to the same level above ground. The length of the tube should be at least the diagonal distance + another 10 - 15'.
- Marker pen
- Drill with ½" drill bits in accordance to the bolt sets supplied. Note: Drilling holes with poor quality or blunt drill bits will add considerable time to the install.
- Drill socket for the self drilling screws
- Wrench set in accordance with the bolt sets supplied.
- A set of cable pullers (come-a-longs) or ratchet straps which are suitable for use on the perimeter cable (item 4) supplied.
- Lengths of spare rope, at least diagonal distance.
- A sturdy ladder or similar equipment to serve as an elevated work platform
- The shade Canopy (Item1). Great care should be taken in the transport of the shadenet membrane. It is easily damaged through abrasion or contact with sharp items. If possible, transport the membrane inside the cab, away from the load bed.
- The Corner Connectors (Item 2)

- The Y Connectors (Item 3)
- Perimeter cable (Item 4) rolled into a coil, tagged
- Hoop pipes (Item 6)
- Hip Pipe (Item 7)
- Hardware
- Fine sandpaper or a fine metal file.

1. Upon arrival on site, re-measure the distances between posts, including the diagonals and check the angles of the posts. Implement the required remedial action, should any undue movement of the posts have taken place. The structure will absorb discrepancies of up to 1 “

2. Leveling the posts: Evaluate the post height to determine they are all at the same height. If they are move to the next step of the installation, if not follow the following steps to cut them down:

- Determine the height above ground at which the posts will be trimmed down to. It is critical that all the posts are trimmed down to the same level. There are 2 ways to do this, the height above ground can either be determined based on distance above floor level or on an artificial horizontal level.
- Height above floor level can only be used on flat or evenly sloped ground. In this instance, if the ground surface is sloped, the top structure will follow the same slope.
- It is recommended that the artificial horizon method is used as it results in a much more appealing finish. It is also the only method that can be used in case of uneven or broken ground.
- By using the plastic clear see-through tube as a water level, the artificial horizontal line can easily be established.
- Determine the desired clearance height for the structure, using the lowest post as datum. Mark this point clearly on the datum post, with the marker pen. The next step would be to mark the remaining 3 post at exactly the same level, thus achieving a top structure that follows the artificial horizon line.
- Ideally from a tap; fill the plastic tube with water, do not close the tap until all the air bubbles are flushed out of the tube.
- You should now have a tube full of water with no air bubbles inside with one person holding each end shut with their thumb to make sure that minimal spillage of water occurs.
- Position the water filled tube between the post with the marker pen mark and the next post to be marked. Ensure it runs straight without any kinks or air bubbles. Ensure that the ends of the tube are still held closed.
- Lift both ends of the tube simultaneously, at both posts, until the air level (meniscus) inside the 1 end of the tube more or less correlates with the leveling mark made on the post with the marker pen. Make sure the other end of the tube is more or less the same height above ground.

- The thumbs can now be removed from the ends of the tube. The meniscus will move up & down inside the tube but will eventually stabilize. Slowly move the miscues to line up with the marker pen mark on the post. Water movement will take place inside the tube.
- It might be required to lift the tube up in order to align the meniscus with the marker. Ensure to lift the other end of the tube at the same time, otherwise water will run out on that end.
- Once the meniscus is on the marker line and has stabilized, mark the other post on the meniscus line as well. Repeat this process until all 4 posts are marked.
- Once this process has been completed, the 4 posts can be trimmed down to the same height, using the pipe cutter. Do **NOT** start the cutting down process until all 4 posts have been marked.

3. Fitting the steel support top structure:

- The 1st step is to conduct a close-up inspection of the Hoop and Hip pipes (Items 6 & 7) and all of the connectors. The shade canopy (Item 1) is easily damaged by any burrs or similar deformities on the metal. Such deformities can easily occur during transportation to the site, so it is important that this function is completed on site, just before installation
- Gently remove any such burrs or deformities, using the sandpaper or a file. Take care to inspect the ends of the hoop & hip tubing, it should be free of burrs and smooth to the touch. The same applies to the Y pieces. Take care not to damage the galvanizing or painted finish. Apply cold galvanize / paint touch up if necessary.
- Place the ladder in the centre of the structure, between the 4 posts. At the same time place the 4 corner connectors (Item 2) on top of each post (Item 5), with the spigot facing towards the centre of the structure.
- Take the Hip Pipe (Item 7) & slide it over 1 end of a Y Connector (Item 3). A Y Connector has 3 ends, 2 of which are relatively close together and face in the same direction. The other end is on its own and faces in the opposite direction, like the bottom leg of a **Y** symbol. In this instance the hip tube should be fitted over the bottom leg. When sliding a tube over a fitting, ensure it slides all the way over until stopped by the stopper. See drawing below:

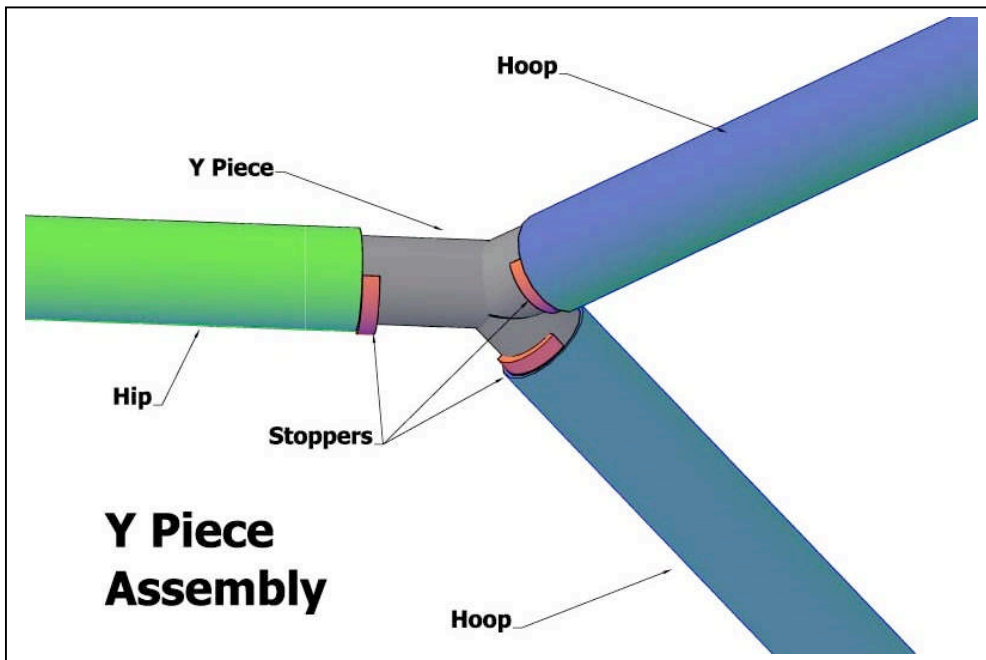

- Now fit a hoop pipe (Item 6) to each remaining end of the Y piece. Lift the whole assembly up, with the hip tube remaining horizontal to the ground level, as it would be once installed. See drawing below.
- Line the spigots of the corner connectors up with the ends of the hoops and slide the hoops over the corner connector spigot. See drawing below

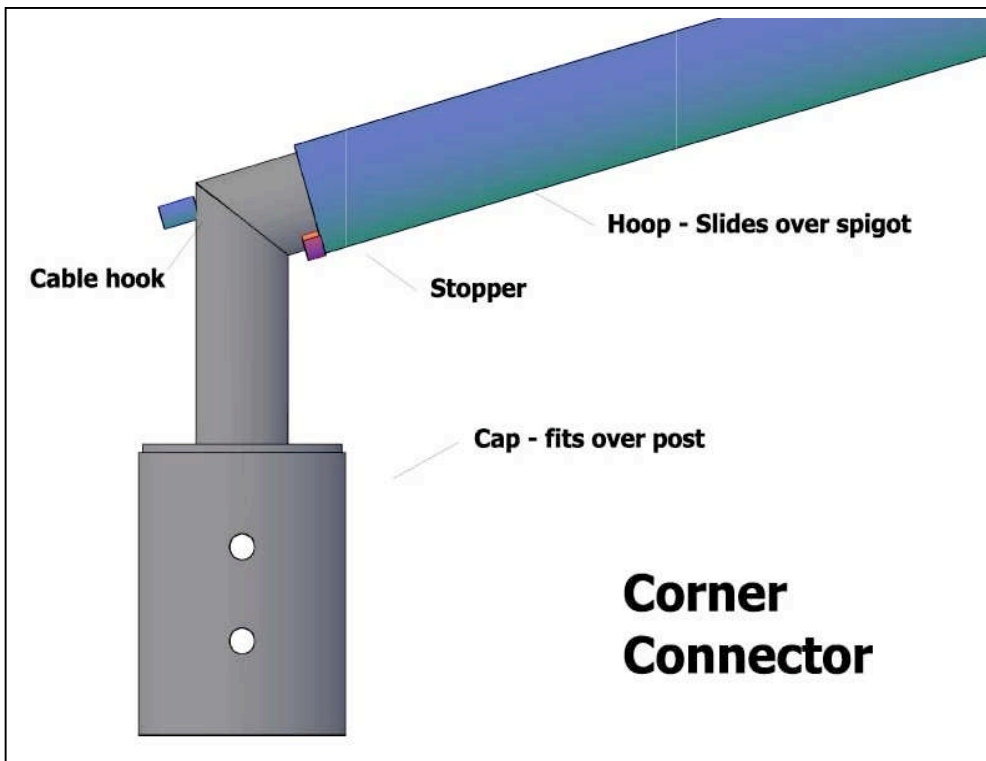

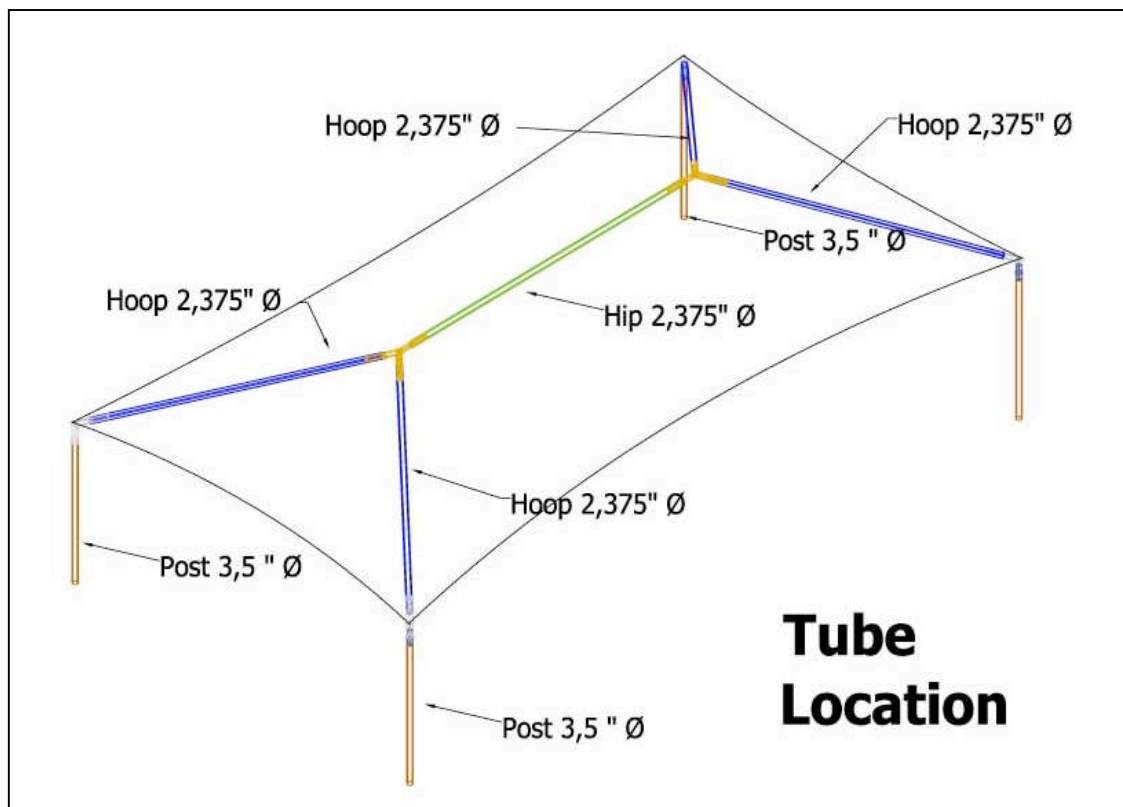

- The tubing arrangement is thus now kept in place by supporting the hip from the ladder and the hoops by the corner connectors. See drawing
- Fit the other Y piece to the end of the hip. Fit the other 2 hoops to the Y piece and slide over the 2 remaining corner connectors.

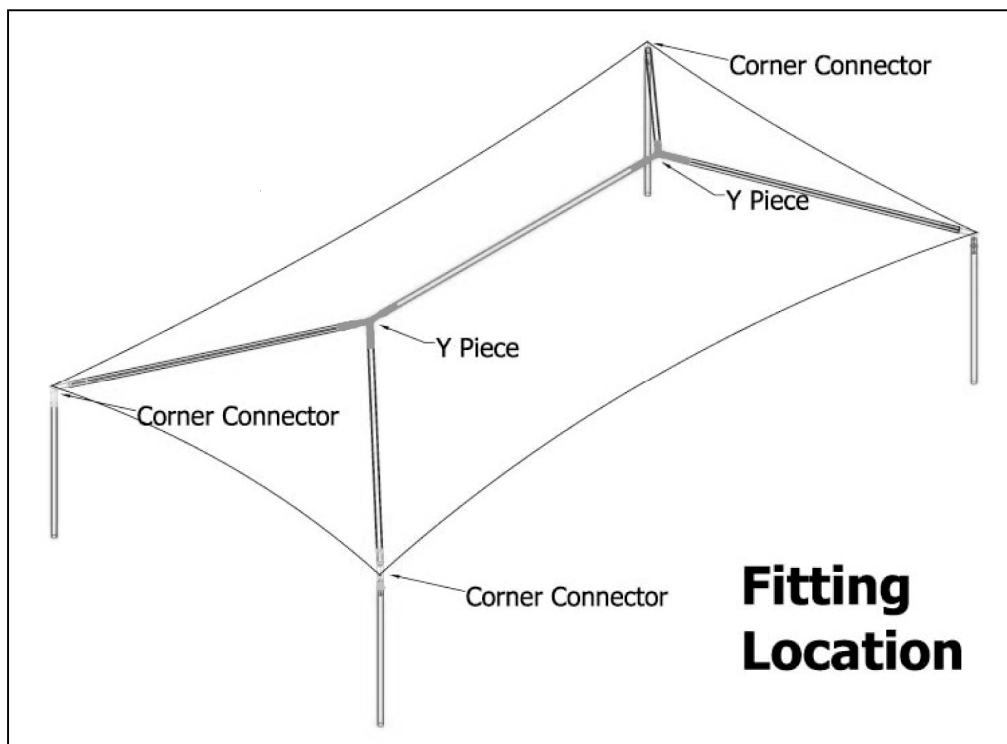

- The whole top structure is now self supportive and no further support from the ladder is required. Ensure that all tubing is fully inserted up to the stopper.

4. Securing the top structure

- Before the shadenet membrane can be fitted, the steel support structure needs to be secured to the posts.
- As it is difficult to line up the corner connectors correctly so the spigots face in line with the hoops, the easiest method is to fit the top structure 1st and then to drill afterwards.
- However, do not attempt to fit the shadenet membrane before the top support structure has been properly secured with bolts through the corner connectors and self drilling screws through the hoops & hip. The Cap part of the corner connectors, already have holes drilled for this purpose.

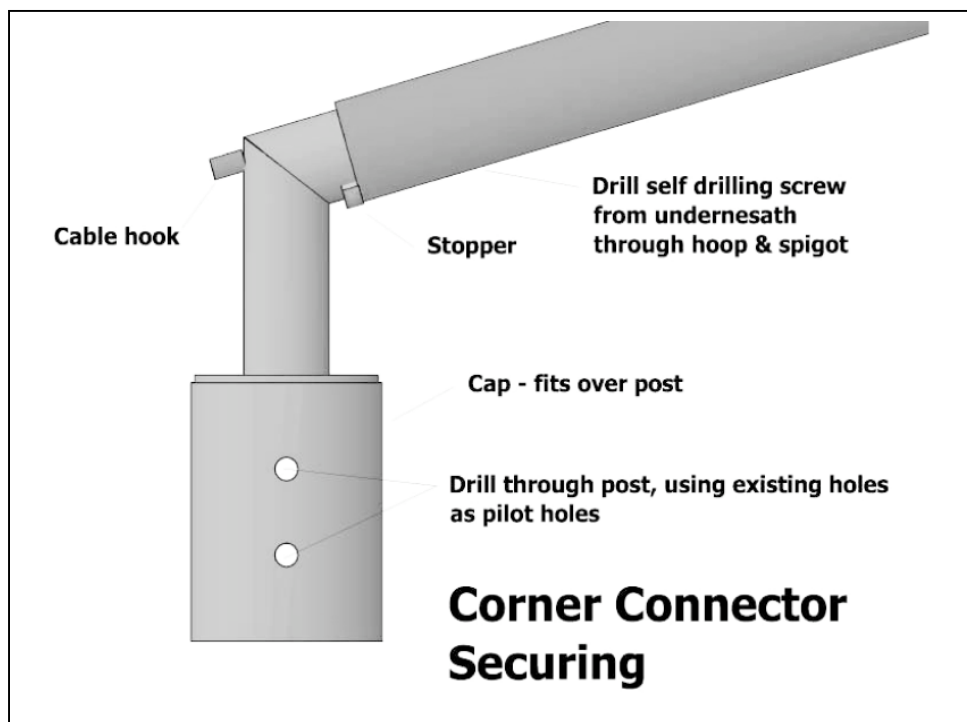

- It is thus simply a process of drilling through the posts, using the holes in the corner connectors as pilot holes.
- Each corner connector requires 1 ½” bolt two washers and 1 nut, as supplied. After the holes have been drilled, fit the bolts and tighten.
- Still on the corner connector, drill a self drilling screw (supplied) from underneath the hoop, +/- 1” away from the stopper. It is important that the self drilling screw passes through the hoop into the spigot of the corner connector.
- On the Y piece, drill a self drilling screw into both hoops and the hip, again +/- 1” away from the respective stoppers. Again take care that the self drilling screw passes through the tube into the V piece fitting.
- Do not drill these self drilling screws from the side of the tubing. Drill from directly underneath, straight up into the tube; in order to prevent any contact between the shadenet membrane and the heads of the self drilling screws.

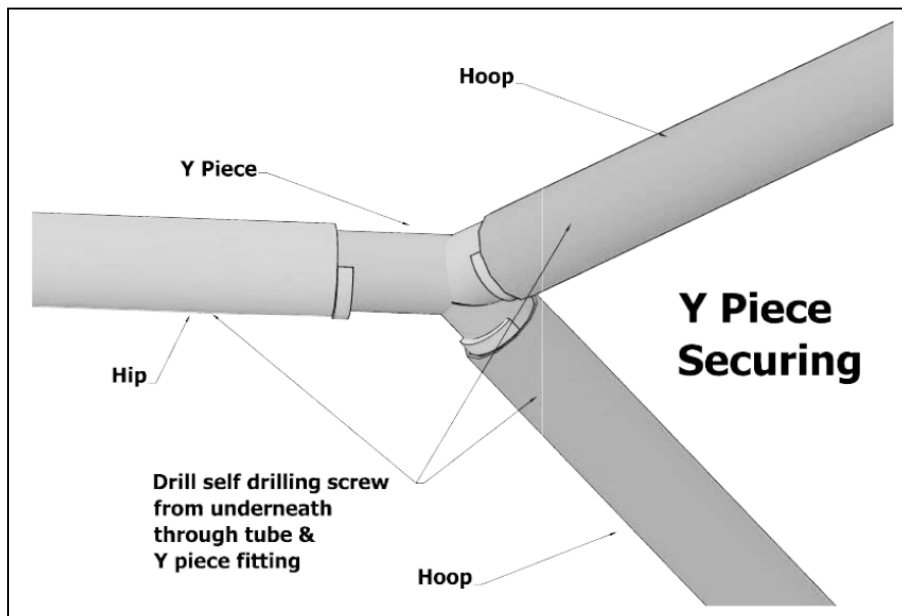

The structure is now ready to have the shadenet membrane fitted.

5. Fitting the shadenet membrane

- Due to the knitted construction of the shadenet fabric, the membrane actually shrinks when exposed to heat / sun.
- Accordingly, do not leave the membrane exposed to direct sunlight, until such time that you are ready to proceed with fitting the membrane.
- It is however necessary to open the membrane on the ground, next to the structure, before it is fitted.
- Prior to this we recommend that this specific area is cleaned and all sharp items that can damage the shadenet, is removed.
- Under **No** circumstances should: **The membrane be dragged along the ground or be walked over or stepped on.**
- Unfold the membrane and orientate it in accordance with the steel support structure. Note that the warranty label should face downwards.
- It is easier to fit the perimeter edge cable while the shadenet membrane is still on the ground. This cable runs through sleeves which are stitched into the edges of the membrane.
- Starting from 1 corner, gently feed the cable through the sleeve. Do not remove the rubber housing on the end of the cable, it is there to protect the sleeve and to avoid accidental damage to the membrane.
- Feed the cable through all 4 sleeves so the 2 remaining ends protrude equal distances from the same corner. The cable is longer than the perimeter distance. This is to enable the cable ends to be pulled & tightened, once the membrane is in place on top of the structure.
- Carefully pull the membrane over the structure from 1 side. Do not jerk the membrane and take great care that it does not get stuck on the support structure.
- The membrane corners have belt loops. We suggest that ropes are tied to these loops as it makes the pulling over process quite easy.
- Once the membrane is in the correct position on top of the steel support structure, hook each belt loop over the hook pin on the corner connector. Again having ropes on the belt hoops will help but ensure the knots are undone on the ropes; otherwise it is very difficult to remove the ropes afterwards.

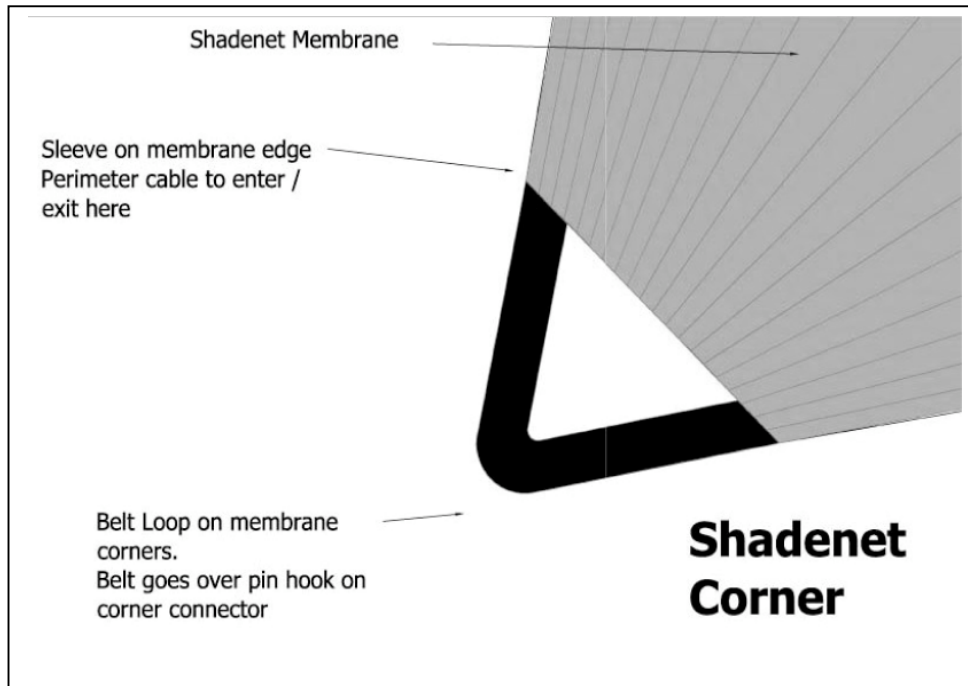

- The membrane should now be in position and held in place by the belt hoops over the hook pins on the corner connectors.
- The cable is fitted through the sleeves and will hang loosely on the outside of the corner connector.

6. Tightening the Perimeter Edge Cable

- By hand pull simultaneously on both ends of the cable until all slack is taken up. Ensure that the cable is hooked underneath the cable hook pin on each corner.
- We recommend that the area underneath the cable hook pin is sprayed with a lubricant such as WD 40 prior to the cable being tightened. This will assist with cable slip around the transition point.
- The cable will slide over the belt loops at each cable hook pin.
- Insert the 2 U clamps (supplied with the cable) at the corner connector at which the 2 cable ends cross each other. Tighten loosely by hand
- Secure the ends of each cable to a ratchet strap and secure the end of the ratchet strap with rope to the adjoining post.
- The objective is; with the help of the ratchet straps, to pull the cable tight in 2 directions. This action must take place simultaneously. Do not attempt to tighten the cable by pulling 1 end only.
- Do not under any circumstances pull the cables with a vehicle.

- With great care not to overdo it, or to bend the posts inwards, gently tighten the cable. Inspect the other 3 corners during this process to ensure the cable has not kinked and that it is sliding easily.
- Correct tension of the cables can be confirmed by testing the movement of the cable along the middle of the 20' span of the structure. It should be possible to push the cable inwards, towards the hip, at least 6".
- Keep thorough lookouts during the cable tightening process for any untoward reactions, such as posts bending, the membrane over-tightening, the cables getting stuck, etc...
- The shadenet membrane should now be firmly in place, secured by both the belt loops and the perimeter edge cable.
- Tighten the 2 U bolts thoroughly to avoid any future cable slippage. Feed the remaining lengths of cable back into the sleeves on the shadenet membrane.
- Remove the ropes, ratchet straps and clean the site thoroughly.

The job is now done.