

6

5

4

3

2

1

D

D

C

C

B

B

A

A

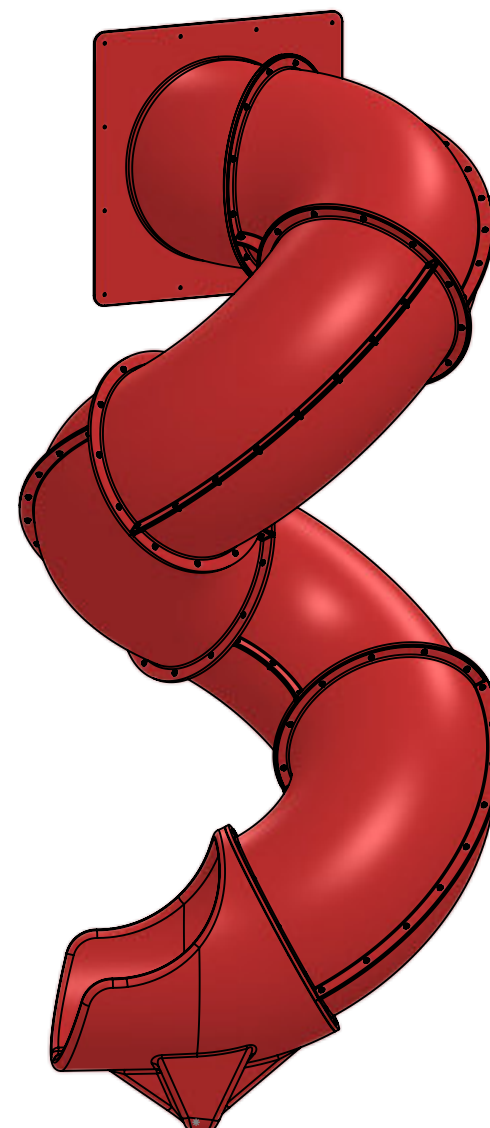
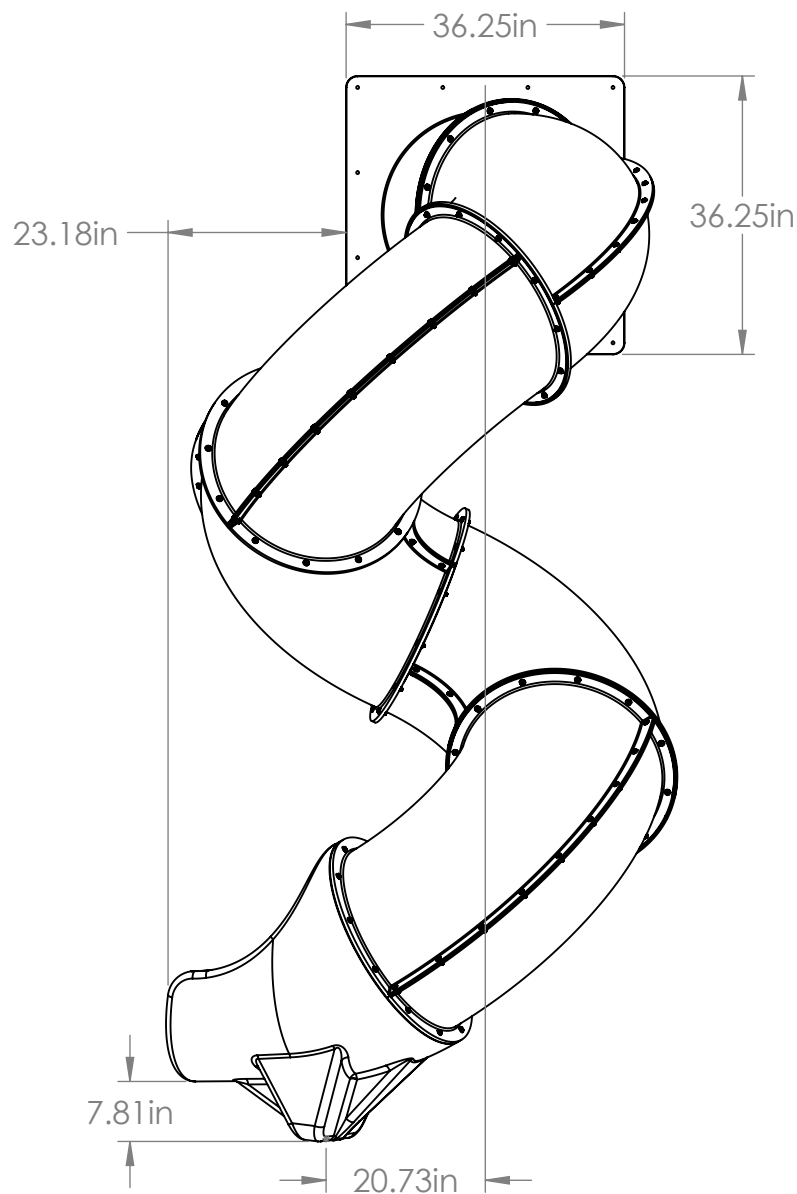
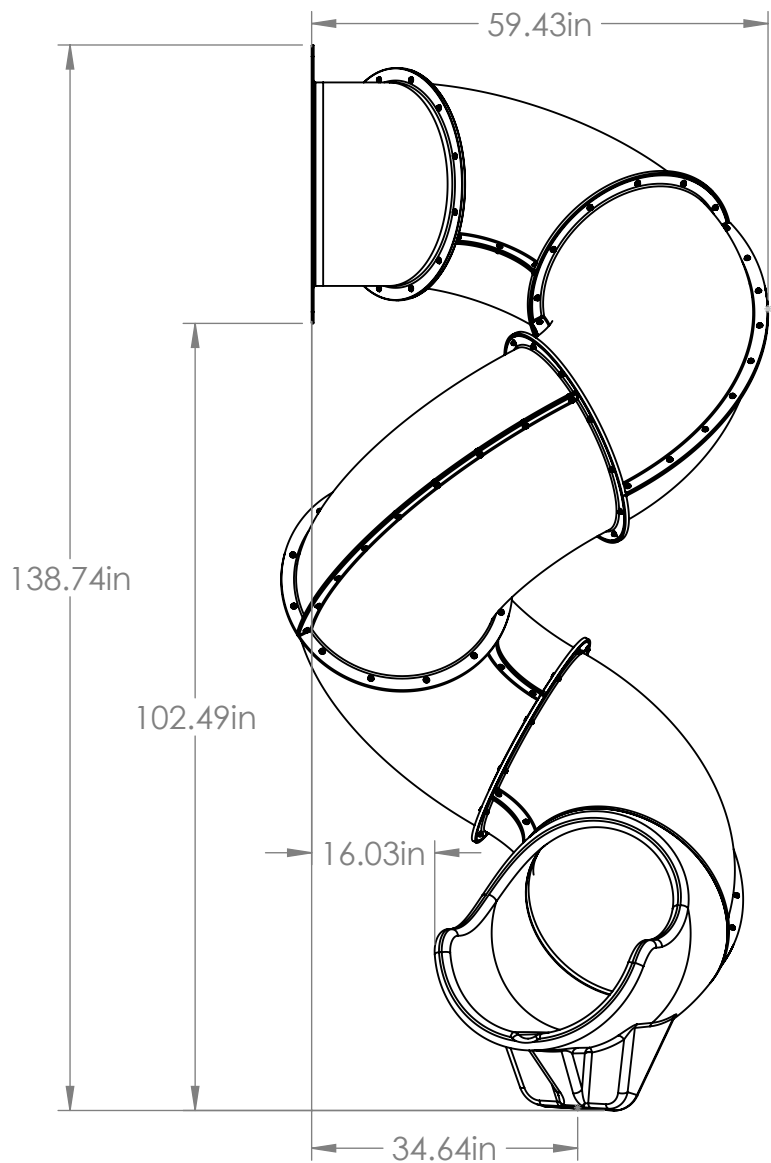
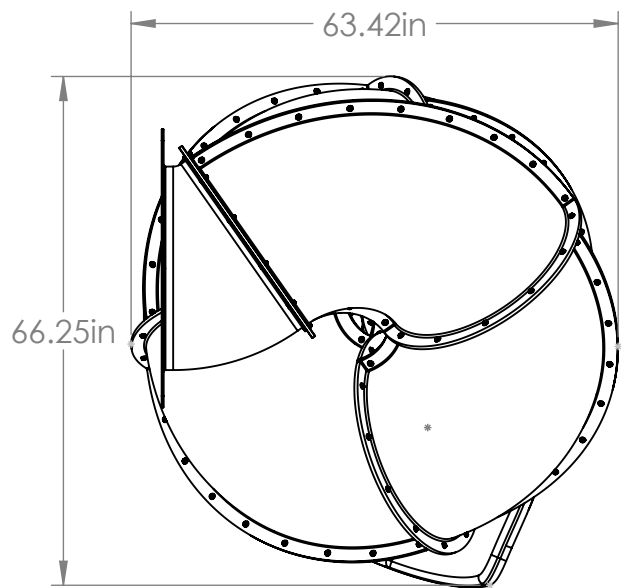

DIMENSIONS ARE IN INCHES
 TOLERANCES:
 FRACTIONAL ±
 ANGULAR: MACH ± BEND ±
 TWO PLACE DECIMAL ±
 THREE PLACE DECIMAL ±

DRAWING TITLE:
 9ft Turbo Twister Slide

6

5

4

3

2

1

SCALE: 1:25